

Stability and Sensitivity Analysis of Fuzzy Control Systems. Mechatronics Applications

Radu-Emil Precup, Stefan Preitl

“Politehnica” University of Timisoara, Dept. of Automation and Appl. Inform.
Bd. V. Parvan 2, RO-300223 Timisoara, Romania
Phone: +40-256-4032-29, -30, -24, -26, Fax: +40-256-403214
E-mail: radu.precup@aut.upt.ro, stefan.preitl@aut.upt.ro

Abstract: The development of fuzzy control systems is usually performed by heuristic means, incorporating human skills, the drawback being in the lack of general-purpose development methods. A major problem, which follows from this development, is the analysis of the structural properties of the control system, such as stability, controllability and robustness. Here comes the first goal of the paper, to present a stability analysis method dedicated to fuzzy control systems with mechatronics applications based on the use of Popov's hyperstability theory. The second goal of this paper is to perform the sensitivity analysis of fuzzy control systems with respect to the parametric variations of the controlled plant for a class of servo-systems used in mechatronics applications based on the construction of sensitivity models. The stability and sensitivity analysis methods provide useful information to the development of fuzzy control systems. The case studies concerning fuzzy controlled servo-systems, accompanied by digital simulation results and real-time experimental results, validate the presented methods.

Keywords: Mamdani fuzzy controllers, stability analysis, sensitivity analysis, mechatronics, servo-systems.

1 Introduction

The development of fuzzy control systems (FCSs) is usually performed by heuristic means, due to the lack of general development methods applicable to large categories of systems. A major problem, which follows from the heuristic method of development, is the analysis of the structural properties of the control systems including the stability analysis and the sensitivity analysis with respect to the parametric variations of the controlled plant. In case of mechatronics applications focussed on servo-systems the analysis of these properties becomes more important due to the very good steady-state and dynamic performance they must ensure. Therefore, the paper aims a twofold goal. Firstly, it presents one stability analysis method dedicated to FCSs applied to servo-systems with mechatronics applications,

involving the use of Popov's hyperstability theory. Secondly, the paper performs the sensitivity analysis of FCSs with respect to the parametric variations of the controlled plant (CP) for a class of servo-systems based on the construction of sensitivity models. The considered FCSs contain Mamdani fuzzy controllers with singleton consequents, seen as type-II fuzzy systems [1, 2].

The stability analysis of an FCS is justified because only a stable FCS can ensure the functionality of the plant and, furthermore, the disturbance reduction, guarantee desired steady states, and reduce the risk of implementing the fuzzy controller (FC). The main approaches in stability analysis of FCSs with Mamdani fuzzy controllers concern: the state-space approach based on a linearized model of the nonlinear system [3, 4], Popov's hyperstability theory [5, 6], Lyapunov's direct method [2, 7], the circle criterion [7, 8], the harmonic balance method [8, 9] referred to also as the describing function method [10, 11], the passivity approach [12], etc.

The sensitivity analysis of the FCSs with respect to the parametric variations of the CP is necessary because the behaviour of these systems is generally reported as "robust" or "insensitive" without offering systematic analysis tools. The sensitivity analysis performed in the paper is based on the idea of approximate equivalence, in certain conditions, between FCSs and linear ones. This is fully justified because of two reasons. The first reason is related with the controller part of the FCS, where the approximate equivalence between linear and fuzzy controllers is generally acknowledged [13, 14]. The second reason is related with the plant part of the FCS. The support for using an FC developed to control a plant having a linear or linearized model is in the fact that this plant model can be considered as a simplified model of a relatively complex model of the CP having nonlinearities or variable parameters or being placed at the lower level of large-scale systems. This is the case of servo-systems in mechatronics applications. Although the plant is nonlinear, it can be linearized in the vicinity of a set of operating points or of a trajectory. The plant model could be also uncertain or not well defined. The FC, as essentially nonlinear element, can compensate for the model uncertainties, nonlinearities and parametric variations of the CP. Fuzzy control must not be seen as a goal in itself, but sometimes the only way to initially approach the control of complex plants.

This paper is organized as follows. It will be treated in the following Section the stability analysis method based on the use of Popov's hyperstability theory. The exemplification of the method is done by a case study regarding the FC development to control an electro-hydraulic servo-system. Then, in Section 3 an approach to the sensitivity analysis of the FCSs for a class of servo-systems with respect to the parametric variations of the CP is presented. This approach is illustrated by a case study regarding the fuzzy control of a nonlinear servo-system. Digital simulation results and real-time experimental results validate the presented approaches. The conclusions are drawn in the end of the paper.

2 Stability Analysis Method Based on Popov's Hyperstability Theory

The SAM based on Popov's hyperstability theory is applied to FCSs to control SISO plants when employing PI-fuzzy controllers (PI-FCSs). The structure of the considered FCS is a conventional one, presented in Fig. 1 (a), where: r – the reference input, y – the controlled output, e – the control error, u – the control signal, d_1, d_2, d_3 – the disturbance inputs.

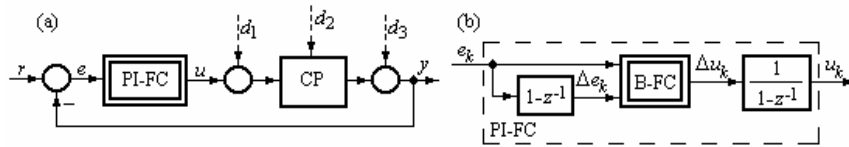

Figure 1
Structure of FCS (a) and of PI-FC (b)

The CP includes the actuator and the measuring devices. The application of an FC, when conditions for linear operating regimes of the plant are validated, determines the FCS to be considered as a Lure-Postnikov type nonlinear control system (for example, see [15]). The PI-FC represents a discrete-time FC with dynamics, introduced by the numerical differentiation of the control error e_k expressed as the increment of control error, $\Delta e_k = e_k - e_{k-1}$, and by the numerical integration of the increment of control signal, Δu_k . The structure of the considered PI-FC is illustrated in Fig. 1 (b), where B-FC represents the basic fuzzy controller, without dynamics.

The block B-FC is a nonlinear two inputs-single output (TISO) system, which includes among its nonlinearities the scaling of inputs and output as part of its fuzzification module. The fuzzification is solved in terms of the regularly distributed (here) input and output membership functions illustrated in Fig. 2. Other distributions of the membership functions can modify in a desired way the controller nonlinearities.

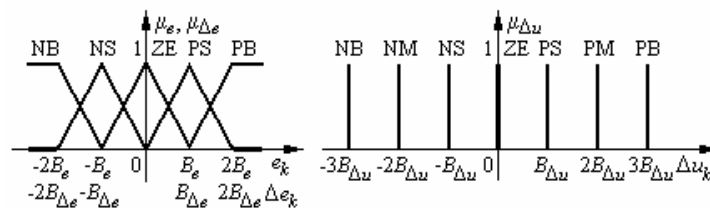

Figure 2
Membership functions of input and output linguistic variables of B-FC

The inference engine in B-FC employs Mamdani's MAX-MIN compositional rule of inference assisted by the rule base presented in Table 1, and the center of gravity method for singletons is used for defuzzification.

Table 1
Decision table of B-FC

$\Delta e_k \setminus e_k$	NB	NS	ZE	PS	PB
PB	ZE	PS	PM	PB	PB
PS	NS	ZE	PS	PM	PB
ZE	NM	NS	ZE	PS	PM
NS	NB	NM	NS	ZE	PS
NB	NB	NB	NM	NS	ZE

To develop the PI-FC the beginning is in the expression of the discrete-time equation of a digital PI controller in its incremental version:

$$\Delta u_k = K_p \cdot \Delta e_k + K_I \cdot e_k = K_p (\Delta e_k + \alpha \cdot e_k), \quad (1)$$

where k is the index of the current sampling interval.

In case of a quasi-continuous digital PI controller the parameters K_p , K_I and α can be calculated as functions of the parameters k_C (gain) and T_i (integral time constant) of a basic original continuous-time PI controller having the transfer function $H_C(s)$:

$$H_C(s) = [k_C / (sT_i)](1 + sT_i), \quad (2)$$

and the connections between $\{K_p, K_I, \alpha\}$ and $\{k_C, T_i\}$ have the following form in the case of using Tustin's discretization method:

$$K_p = k_C [1 - T_s / (2T_i)], \quad K_I = k_C T_s / T_i, \quad \alpha = K_I / K_p = 2T_s / (2T_i - T_s), \quad (3)$$

with T_s – the sampling period chosen in accordance with the requirements of quasi-continuous digital control.

The design relations for the PI-FC are obtained by the application of the modal equivalence principle [16] transformed into (4) in this case:

$$B_{\Delta e} = \alpha B_e, \quad B_{\Delta u} = K_I B_e, \quad (4)$$

where the free parameter B_e represents designer's option. Using the experience in controlling the plant one can choose the value of this parameter, but firstly it must be chosen to ensure the aim of a stable FCS.

The CP is supposed to be characterized by the following n -th order discrete-time SISO linear time-invariant state mathematical model (MM) including the zero-order hold:

$$\begin{aligned} \mathbf{x}_{k+1} &= \mathbf{A} \cdot \mathbf{x}_k + \mathbf{b} \cdot u_k \\ y_k &= \mathbf{c}^T \cdot \mathbf{x}_k \end{aligned} \quad (5)$$

where: u_k – the control signal; y_k – the controlled output; \mathbf{x}_k – the state vector, $\dim \mathbf{x}_k = (n,1)$; \mathbf{A} , \mathbf{b} , \mathbf{c}^T – matrices with the dimensions: $\dim \mathbf{A} = (n, n)$, $\dim \mathbf{b} = (n, 1)$, $\dim \mathbf{c}^T = (1, n)$.

To derive the stability analysis method it is necessary to transform the initial FCS structure into a multivariable one because the block B-FC in Fig.X.5 is a TISO system. This modified FCS structure is illustrated in Fig. 3 (a), where the dynamics of the fuzzy controller (its linearized part) is transferred to the plant (CP) resulting in the extended controlled plant (ECP, a linear one). The vectors in Fig. 3 (a) represent: \mathbf{r}_k – the reference input vector, \mathbf{e}_k – the control error vector, \mathbf{y}_k – the controlled output vector, \mathbf{u}_k – the control signal vector. For the general use (in the continuous time, too) the index k may be omitted, and these vectors are defined as follows:

$$\mathbf{r}_k = [r_k \quad \Delta r_k]^T, \quad \mathbf{e}_k = [e_k \quad \Delta e_k]^T, \quad \mathbf{y}_k = [y_k \quad \Delta y_k]^T, \quad (6)$$

where $\Delta v_k = v_k - v_{k-1}$ stands generally for the increment of the variable v_k .

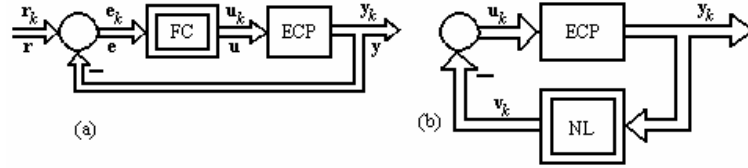

Figure 3

Modified structure of FCS (a) and structure used in stability analysis (b)

In relation with Fig. 3 (a), the block FC is characterized by the nonlinear input-output static map \mathbf{F} :

$$\mathbf{F} : R^2 \rightarrow R^2, \quad \mathbf{F}(\mathbf{e}_k) = [f(\mathbf{e}_k), 0]^T, \quad (7)$$

where $f(f : R^2 \rightarrow R)$ is the input-output static map of the nonlinear TISO system B-FC in Fig. 1.

As it can be observed in (6), all variables in the FCS structure (in Fig. 3 (a)) have two components. This requires the introduction of a fictitious control signal, supplementary to the outputs of the block B-FC, for obtaining an equal number of inputs and outputs as required by the hyperstability theory in the multivariable case.

Generally speaking, the structure involved in the stability analysis of an unforced nonlinear control system ($\mathbf{r}_k = \mathbf{0}$ and the disturbance inputs are also zero) is presented in Fig. 3 (b). The block NL in Fig. 3 (b) represents a static nonlinearity due to the nonlinear part without dynamics of the block FC in Fig. 3 (a). The connections between the variables of the control system structures in Fig. 3 are:

$$\mathbf{v}_k = -\mathbf{u}_k = -\mathbf{F}(\mathbf{e}_k), \quad \mathbf{y}_k = -\mathbf{e}_k, \quad (8)$$

with the second component of \mathbf{F} being always zero to neglect the effect of the fictitious control signal.

The MM of the ECP can be derived by firstly defining the additional state variables $\{x_{uk}, x_{yk}\}$ according to Fig. 4. Then, the extended state vector \mathbf{x}_k^E and the control signal vector \mathbf{u}_k^E can be expressed in terms of (9):

$$\mathbf{x}_k^E = [\mathbf{x}_k^T \quad x_{uk} \quad x_{yk}]^T, \quad \mathbf{u}_k^E = [\Delta u_k \quad \Delta u_{fk}]^T, \quad (9)$$

where Δu_{fk} stands for the fictitious increment of control signal.

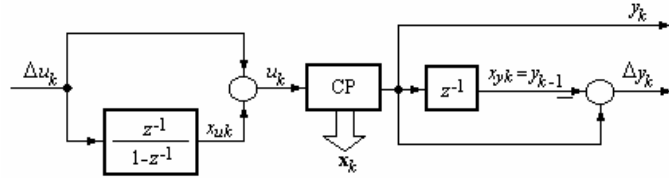

Figure 4
Structure of ECP block

Using the structure presented in Fig. 4, the $(n+2)$ -th order discrete-time state MM of the ECP becomes (10):

$$\begin{aligned} \mathbf{x}_{k+1}^E &= \mathbf{A}^E \cdot \mathbf{x}_k^E + \mathbf{B}^E \cdot \mathbf{u}_k^E, \\ \mathbf{y}_k^E &= \mathbf{C}^E \cdot \mathbf{x}_k^E \end{aligned} \quad (10)$$

with the matrices \mathbf{A}^E ($\dim \mathbf{A}^E = (n+2, n+2)$), \mathbf{B}^E ($\dim \mathbf{B}^E = (n+2, 2)$) and \mathbf{C}^E ($\dim \mathbf{C}^E = (2, n+2)$) expressed as follows:

$$\mathbf{A}^E = \begin{bmatrix} \mathbf{A} & \mathbf{b} & \mathbf{0} \\ \mathbf{0}^T & 1 & 0 \\ \mathbf{c}^T & 0 & 0 \end{bmatrix}, \quad \mathbf{B}^E = \begin{bmatrix} \mathbf{b} & \mathbf{1} \\ 1 & 1 \\ 0 & 1 \end{bmatrix}, \quad \mathbf{C}^E = \begin{bmatrix} \mathbf{c}^T & 0 & 0 \\ \mathbf{c}^T & 0 & -1 \end{bmatrix}. \quad (11)$$

Then, the second equations in (8) and (10) can be transformed into the following equivalent expressions:

$$\mathbf{e}_k = -\mathbf{C}^E \cdot \mathbf{x}_k, \quad \mathbf{x}_k = \mathbf{C}^b \cdot \mathbf{e}_k, \quad (12)$$

where the matrix \mathbf{C}^b , $\dim \mathbf{C}^b = (n+2, 2)$, can be calculated relatively easy as function of \mathbf{C}^E .

The main part of the proposed stability analysis method can be stated in terms of the following theorem giving sufficient stability conditions.

Theorem 1. The nonlinear system, with the structure presented in Fig. 3 (b) and the MM of its linear part (10), is globally asymptotically stable if:

- the three matrices \mathbf{P} (positive definite, $\dim \mathbf{P} = (n+2, n+2)$), \mathbf{L} (regular, $\dim \mathbf{L} = (n+2, n+2)$) and \mathbf{V} (any, $\dim \mathbf{V} = (n+2, 2)$) fulfill the requirements (13):

$$\begin{aligned} (\mathbf{A}^E)^T \cdot \mathbf{P} \cdot \mathbf{A}^E &= -\mathbf{L} \cdot \mathbf{L}^T \\ \mathbf{C}^E - (\mathbf{B}^E)^T \cdot \mathbf{P} \cdot \mathbf{A}^E &= \mathbf{V}^T \cdot \mathbf{L}^T, \\ -(\mathbf{B}^E)^T \cdot \mathbf{P} \cdot \mathbf{B}^E &= \mathbf{V}^T \cdot \mathbf{V} \end{aligned} \quad (13)$$

- introducing the matrices \mathbf{M} ($\dim \mathbf{M} = (2, 2)$), \mathbf{N} ($\dim \mathbf{N} = (2, 2)$) and \mathbf{R} ($\dim \mathbf{R} = (2, 2)$) defined in terms of (14):

$$\begin{aligned} \mathbf{M} &= (\mathbf{C}^b)^T \cdot (\mathbf{L} \cdot \mathbf{L}^T - \mathbf{P}) \cdot \mathbf{C}^b \\ \mathbf{N} &= (\mathbf{C}^b)^T \cdot [\mathbf{L} \cdot \mathbf{V} - (\mathbf{A}^E)^T \cdot \mathbf{P} \cdot \mathbf{B}^E - 2(\mathbf{C}^E)^T], \\ \mathbf{R} &= \mathbf{V}^T \cdot \mathbf{V} \end{aligned} \quad (14)$$

the Popov-type inequality (15) holds for any value of the control error e_k :

$$f(\mathbf{e}_k) \cdot \mathbf{n}^T \cdot \mathbf{e}_k + (\mathbf{e}_k)^T \cdot \mathbf{M} \cdot \mathbf{e}_k \geq 0, \quad (15)$$

where \mathbf{n} represents the first column in \mathbf{N} .

The proof of Theorem 1, based on the Kalman-Szegö lemma [17] and on processing the Popov sum, is presented in [18] for the PI-FCs with prediction.

By taking into account these aspects, the stability analysis method dedicated to FCSs with PI-FCs consists of the following steps:

- step (a): express the MM of the CP, choose the sampling period T_s and calculate the discrete-time state-space MM of the CP with the zero-order hold, (5),
- step (b): derive the discrete-time state-space mathematical model of the ECP, (10),
- step (c): compute the matrix \mathbf{C}^b in terms of (12),
- step (d): solve the system of equations (13), with the solutions \mathbf{P} , \mathbf{L} and \mathbf{V} , and calculate the matrices \mathbf{M} , \mathbf{N} and \mathbf{R} in (14),
- step (e): set the value of the free parameter $B_e > 0$ of the PI-FC, and tune the other parameters of the PI-FC in terms of (4),
- step (f): check the stability condition (15) for any values of PI-FC inputs in operating regimes considered to be significant for FCS behaviour.

To test the presented stability analysis method it is considered the CP of an electro-hydraulic servo-system (EHS) used as actuator in mechatronics applications, with the structure presented in Fig. 5 (a) [19], where: NL 1 ... NL 5 – nonlinearities, EHC – electro-hydraulic converter, SVD – slide-valve distributor, MSM – main

servo-motor, M 1 and M 2 – measuring devices; u – control signal, y – controlled output; x_1 and x_2 – state variables; x_{1M} and x_{2M} – measured state variables, $u_l = 10$ V, $g_0 = 0.0625$ mm/V, $\varepsilon_2 = 0.02$ mm, $\varepsilon_4 = 0.2$ mm, $x_{l1} = 21.8$ mm, $y_l = 210$ mm, $T_{i1} = 0.001872$ sec, $T_{i2} = 0.0756$ sec, $k_{M1} = 0.2$ V/mm, $k_{M2} = 0.032$ V/mm. To obtain a relatively simple FC, the CP is represented here by the stabilized electro-hydraulic servo-system (SEHS), and the FCS structure is presented in Fig. 5 (b). The SEHS represents itself a state feedback control system, with AA – adder amplifier, and k_{x1} , k_{x2} , k_{AA} – parameters of the state feedback controller. By omitting the nonlinearities of the EHS, imposing the double pole of the SEHS in -1 , the pole placement method leads to the transfer function of the SEHS block, $H_{CP}(s)$:

$$H_{CP}(s) = \frac{1/k_{x2}}{1 + [k_{M1}T_{i2}k_{x1}/(k_{AA}k_{M2}k_{x2})]s + [T_{i1}T_{i2}/(g_0k_{AA}k_{M2})]s^2} = \frac{1}{(1+s)^2}, \quad (16)$$

obtained for $k_{x1} = 0.2997$, $k_{x2} = 1$, $k_{AA} = 0.0708$.

The steps of the stability analysis method have been proceeded, but only the values of \mathbf{M} and \mathbf{n}^T are presented because these two matrices appear in the stability condition (15), tested by digital simulation:

$$\mathbf{M} = \begin{bmatrix} 2.0071 & 0 \\ 0 & 0 \end{bmatrix}, \quad \mathbf{n}^T = [0.9855 \quad 0], \quad (17)$$

and the parameters of the PI-FC ensuring the stability of the FCS have been tuned as: $B_e = 0.3$, $B_{\Delta e} = 0.0076$, $B_{\Delta u} = 0.0203$. To verify the stability of all FCS the dynamic behaviour of the free control system was simulated, when the system started from two different, arbitrarily chosen, initial states, obtained by feeding a $d_3 = -0.5$ and a $d_3 = -1.5$ disturbance input according to Fig. 1 (a). The FCS behaviour is presented in Fig. 6, and it illustrates that the FCS analyzed by using the presented SAM is stable.

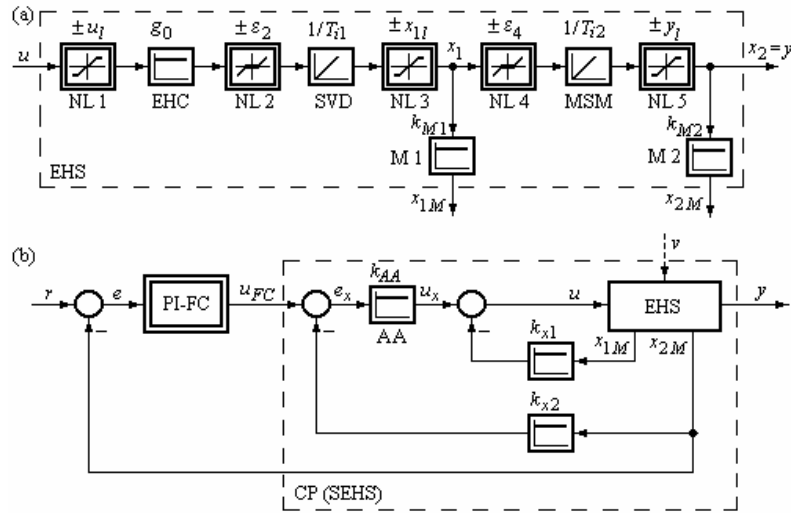

Figure 5
Structure of EHS as CP (a) and structure of FCS (b)

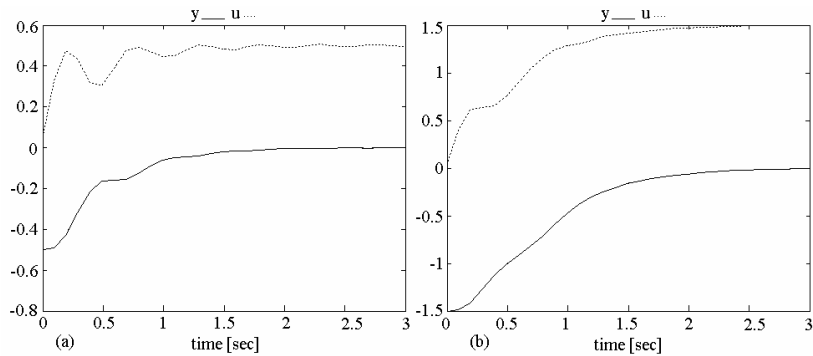

Figure 6
FCS behaviour for $d_3 = -0.5$ (a) and $d_3 = -1.5$ (b)

3 Sensitivity Analysis of a Class of Fuzzy Control Systems. Case Study

Let the considered control system structure be a conventional one, presented in Fig. 7 (a), where: C – controller, CP – controlled plant, RF – the reference filter, r – reference input, \tilde{r} – filtered reference input, e – control error, u – control signal, y – controlled output, d_1, d_2, d_3, d_4 – disturbance inputs. Depending on the place of

feeding the disturbance inputs to the CP and on the CP structure, the accepted types of disturbance inputs $\{d_1, d_2, d_3, d_4\}$ are defined in terms of Fig. 7 (b).

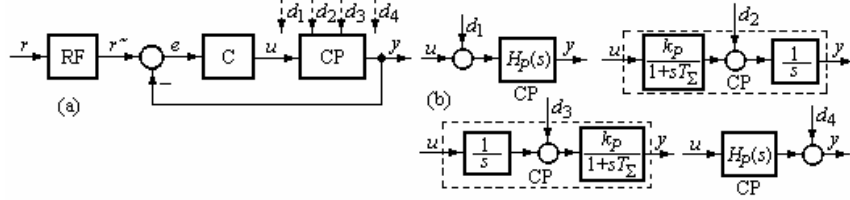

Figure 7

Control system structure (a) and disturbance inputs types (b)

The class of plants with the simplified structure illustrated in Fig. 7 (a), is considered to be linearized around a steady-state operating point and characterized by the transfer function $H_p(s)$:

$$H_p(s) = k_p / [s(1 + T_\Sigma s)], \quad (18)$$

with k_p – gain and T_Σ – small time constant or sum of all parasitic time constants, belongs to a class of integral-type systems with variable parameters in case of servo-systems with mechatronics applications.

For these plants, it is recommended the use of linear PI controllers having the transfer function $H_C(s)$ in (2) with $k_c = k_c T_i$. Based on the Extended Symmetrical Optimum (ESO) method [19], the parameters of the controller $\{k_c$ (or k_c) – controller gain, T_i – integral time constant} are tuned in terms of (19) guaranteeing the desired control system performance by means of a single design parameter, β :

$$k_c = 1/(\beta^{3/2} k_p T_\Sigma^2), \quad T_i = \beta T_\Sigma, \quad k_c = 1/(\beta^{1/2} k_p T_\Sigma). \quad (19)$$

According to [20], the variation of CP parameters ($\{k_p, T_\Sigma\}$ for the considered CPs) due to the change of the steady-state operating points or to other conditions leads to additional motion (of the control systems). This motion is usually undesirable under uncontrollable parametric variations. Therefore, to alleviate the effects of parametric disturbances it is necessary to perform the sensitivity analysis with respect to the parametric variations of the CP.

It is generally accepted that FCs ensure control system performance enhancement with respect to the modifications of the reference input, of the load disturbance inputs or to parametric variations. This justifies the research efforts focused on the systematic analysis of FCSs behaviour with respect to parametric variations and the need to perform the sensitivity analysis with this respect that enables to derive sensitivity models for the FCs and for the overall FCSs.

The sensitivity models enable the sensitivity analysis of the FCSs accepted, as mentioned in Section 1, to be approximately equivalent with the linear control

systems. This justifies the approach to be presented in the sequel, that the sensitivity models of the FCSs are approximately equivalent to the sensitivity models of the linear ones. Therefore, it is necessary to obtain firstly the sensitivity models of the linear control system in Fig. 7 (a).

Defining the state sensitivity functions $\{\lambda_1, \lambda_2, \lambda_3\}$ and the output sensitivity function, σ , there have been derived several sensitivity models, four of them being presented as follows:

- with respect to the variation of k_p , the step modification of r , and $d_3(t) = 0$:

$$\begin{aligned}
\dot{\lambda}_1(t) &= \lambda_2(t), \\
\dot{\lambda}_2(t) &= -[1/(\beta^{1/2}T_{\Sigma 0}^2)]\lambda_1(t) - (1/T_{\Sigma 0})\lambda_2(t) + [1/(\beta^{1/2}T_{\Sigma 0}^2)]\lambda_3(t) - \\
&\quad - [1/(\beta^{1/2}k_{p0}T_{\Sigma 0}^2)]x_{10}(t) + [1/(\beta^{1/2}k_{p0}T_{\Sigma 0}^2)]x_{30}(t) + \\
&\quad + [1/(\beta^{1/2}k_{p0}T_{\Sigma 0}^2)]r_0(t), \\
\dot{\lambda}_3(t) &= -[1/(\beta T_{\Sigma 0})]\lambda_1(t), \\
\sigma(t) &= \lambda_1(t),
\end{aligned} \tag{20}$$

- with respect to the variation of T_{Σ} , the step modification of r , and $d_3(t) = 0$:

$$\begin{aligned}
\dot{\lambda}_1(t) &= \lambda_2(t), \\
\dot{\lambda}_2(t) &= -[1/(\beta^{1/2}T_{\Sigma 0}^2)]\lambda_1(t) - (1/T_{\Sigma 0})\lambda_2(t) + [1/(\beta^{1/2}T_{\Sigma 0}^2)]\lambda_3(t) + \\
&\quad + [1/(\beta^{1/2}T_{\Sigma 0}^3)]x_{10}(t) + (1/T_{\Sigma 0}^2)x_{20}(t) - [1/(\beta^{1/2}T_{\Sigma 0}^3)]x_{30}(t) - \\
&\quad - [1/(\beta^{1/2}T_{\Sigma 0}^3)]r_0(t), \\
\dot{\lambda}_3(t) &= -[1/(\beta T_{\Sigma 0})]\lambda_1(t), \\
\sigma(t) &= \lambda_1(t),
\end{aligned} \tag{21}$$

- with respect to the variation of k_p , the step modification of d_3 , and $r(t) = 0$:

$$\begin{aligned}
\dot{\lambda}_1(t) &= -(1/T_{\Sigma 0})\lambda_1(t) + (k_{p0}/T_{\Sigma 0})\lambda_2(t) + (1/T_{\Sigma 0})x_{20}(t) + \\
&\quad + (1/T_{\Sigma 0})d_{30}(t), \\
\dot{\lambda}_2(t) &= -[1/(\beta^{1/2}k_{p0}T_{\Sigma 0})]\lambda_1(t) + [1/(\beta^{1/2}k_{p0}T_{\Sigma 0})]\lambda_3(t), \\
\dot{\lambda}_3(t) &= -[1/(\beta T_{\Sigma 0})]\lambda_1(t), \\
\sigma(t) &= \lambda_1(t),
\end{aligned} \tag{22}$$

- with respect to the variation of T_{Σ} , the step modification of d_3 , and $r(t) = 0$:

$$\begin{aligned}
\dot{\lambda}_1(t) &= -(1/T_{\Sigma 0})\lambda_1(t) + (k_{p0}/T_{\Sigma 0})\lambda_2(t) + (1/T_{\Sigma 0}^2)x_{10}(t) - \\
&\quad - (k_{p0}/T_{\Sigma 0}^2)x_{20}(t) - (k_{p0}/T_{\Sigma 0}^2)d_{30}(t), \\
\dot{\lambda}_2(t) &= -[1/(\beta^{1/2}k_{p0}T_{\Sigma 0})]\lambda_1(t) + [1/(\beta^{1/2}k_{p0}T_{\Sigma 0})]\lambda_3(t), \\
\dot{\lambda}_3(t) &= -[1/(\beta T_{\Sigma 0})]\lambda_1(t), \\
\sigma(t) &= \lambda_1(t).
\end{aligned} \tag{23}$$

The PI-FC development is applied in a nonlinear laboratory DC drive, AMIRA DR300. The DC motor is loaded using a current controlled DC generator, mounted on the same shaft, and the drive has built-in analog current controllers for both DC machines with rated speed of 3000 rpm, rated power equal to 30 W, and rated current equal to 2 A. The speed control of the DC motor is digitally implemented using an A/D – D/A data converter card. The speed sensors are a tacho generator and an additional incremental rotary encoder mounted at the free drive-shaft.

The speed response of the FCS with RF and PI-FC without load is shown in Fig. 8.

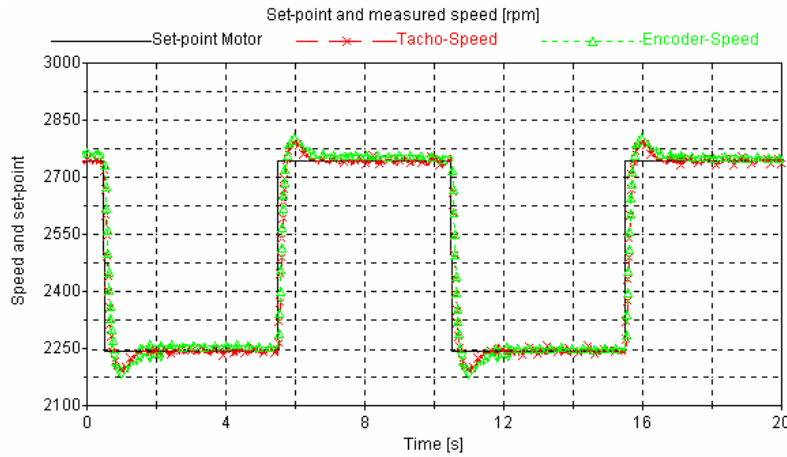

Figure 8
Speed response of FCS without load

Conclusions

The paper presents one stability analysis method and performs a sensitivity analysis of fuzzy control systems with Mamdani fuzzy controllers dedicated to control of servo-systems in mechatronics applications.

The methods can be formulated under the form of useful design recommendations for the fuzzy controllers.

The case studies presented in the paper, accompanied by digital simulation results and by experimental results, validate the theoretical approaches.

References

- [1] Kóczy, L. T.: Fuzzy If ... Then rule models and their transformation into one another, IEEE Transactions on Systems, Man, and Cybernetics - Part A, 1996, vol. 26, pp. 621-637
- [2] Sugeno, M.: On stability of fuzzy systems expressed by fuzzy rules with singleton consequents, IEEE Trans. Fuzzy Syst., 1999, vol. 7, pp. 201-224
- [3] Aracil, J., A. Ollero, and A. Garcia-Cerezo: Stability indices for the global analysis of expert control systems, IEEE Transactions on Systems, Man, and Cybernetics, 1989, vol. 19, pp. 998-1007
- [4] Precup, R.-E., S. Doboli, and S. Preitl: Stability analysis and development of a class of fuzzy control systems, Engineering Applications of Artificial Intelligence, 2000, vol. 13, pp. 237-247
- [5] Opitz, H.-P.: Fuzzy control and stability criteria, Proceedings of First EUFIT'93 European Cong., Aachen, Germany, 1993, vol. 1, pp. 130-136
- [6] Precup, R.-E. and S. Preitl: Popov-type stability analysis method for fuzzy control systems, Proceedings of Fifth EUFIT'97 European Congress, Aachen, Germany, 1997, vol. 2, pp. 1306-1310
- [7] Passino, K. M. and S. Yurkovich: Fuzzy Control, Addison Wesley Longman, Inc., Menlo Park, CA, 1998
- [8] Driankov, D., H. Hellendoorn and M. Reinfrank: An Introduction to Fuzzy Control, Springer-Verlag, Berlin, Heidelberg, New York, 1993
- [9] Kiendl, H.: Harmonic balance for fuzzy control systems, Proc. of First EUFIT' European Cong., Aachen, Germany, 1993, vol. 1, pp. 137-141
- [10] Ying, H.: Analytical structure of a two-input two-output fuzzy controller and its relation to PI and multilevel relay controllers, Fuzzy Sets and Systems, 1994, vol. 63, pp. 21-33
- [11] Gordillo, F., J. Aracil and T. Alamo: Determining limit cycles in fuzzy control systems, Proceedings of FUZZ-IEEE'97 Conference, Barcelona, Spain, 1997, pp. 193-198
- [12] Calcev, G.: Some remarks on the stability of Mamdani fuzzy control systems, IEEE Transactions on Fuzzy Systems, 1998, vol. 6, pp. 436-442
- [13] Tang, K. L. and R. J. Mulholland: Comparing fuzzy logic with classical controller designs, IEEE Transactions on Systems, Man, and Cybernetics, 1987, vol. 17, pp. 1085-1087
- [14] Moon, B. S.: Equivalence between fuzzy logic controllers and PI controllers for Single Input systems, Fuzzy Sets and Syst., 1995, vol. 69, pp. 105-113

- [15] Hill, D. J. and C. N. Chong: Lyapunov functions of Lure-Postnikov form for structure preserving models of power plants, *Automatica*, 1989, vol. 25, pp. 453-460
- [16] Galichet, S. and L. Foulloy: Fuzzy controllers: synthesis and equivalences, *IEEE Transactions on Fuzzy Systems*, 1995, vol. 3, pp. 140-148
- [17] Landau, I. D.: *Adaptive Control*, Marcel Dekker, Inc., New York, 1979
- [18] Precup, R.-E., S. Preitl, and G. Faur: PI predictive fuzzy controllers for electrical drive speed control: methods and software for stable development, *Computers in Industry*, 2003, vol. 52, pp. 253-270
- [19] Preitl, S. and R.-E. Precup: An extension of tuning relations after Symmetrical Optimum method for PI and PID controllers, *Automatica*, 1999, vol. 35, pp. 1731-1736
- [20] Rosenwasser, E. and R. Yusupov: *Sensitivity of Automatic Control Systems*, CRC Press, Boca Raton, FL, 2000